

Raspberry Pi Pico for Radio Amateurs

Program and build RPi Pico-based ham station
utilities, tools, and instruments

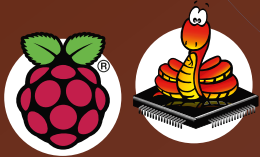
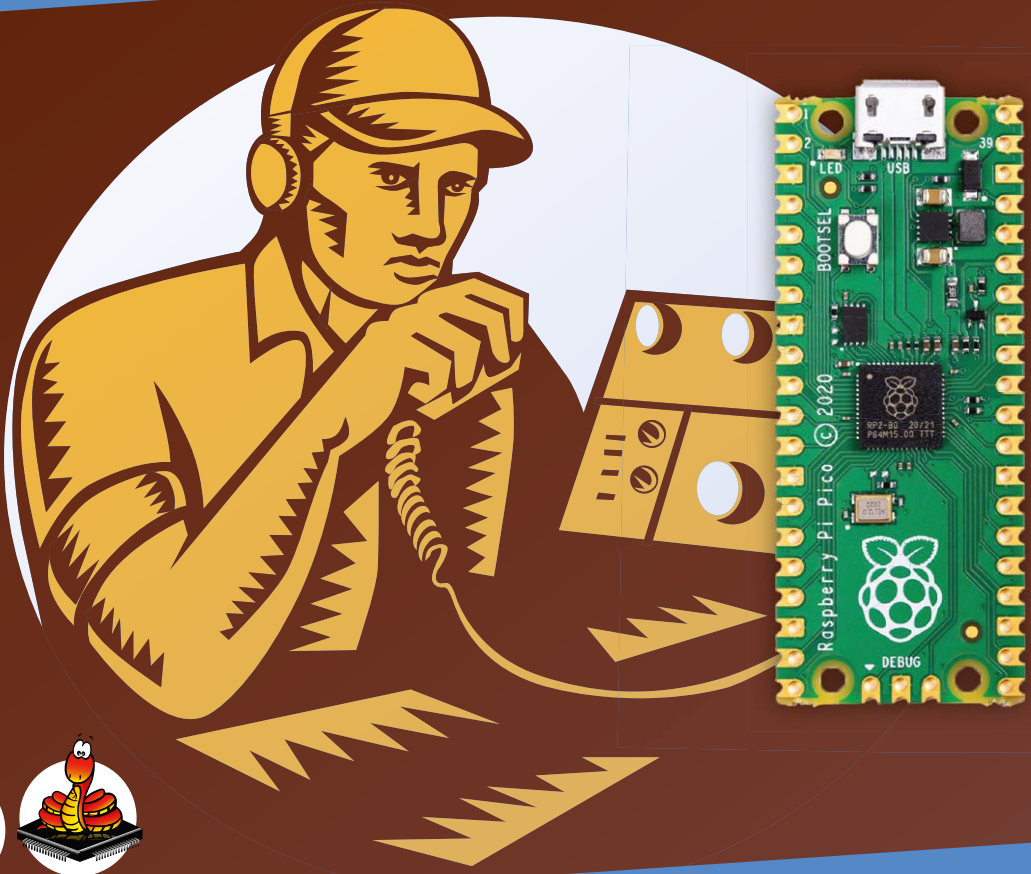

Dogan Ibrahim, G7SCU

Raspberry Pi Pico for Radio Amateurs

Program and build RPi Pico-based hams station utilities, tools, and instruments



Dogan Ibrahim, G7SCU

● This is an Elektor Publication. Elektor is the media brand of Elektor International Media B.V.
PO Box 11, NL-6114-ZG Susteren, The Netherlands
Phone: +31 46 4389444

● All rights reserved. No part of this book may be reproduced in any material form, including photocopying, or storing in any medium by electronic means and whether or not transiently or incidentally to some other use of this publication, without the written permission of the copyright holder except in accordance with the provisions of the Copyright Designs and Patents Act 1988 or under the terms of a licence issued by the Copyright Licencing Agency Ltd., 90 Tottenham Court Road, London, England W1P 9HE. Applications for the copyright holder's permission to reproduce any part of the publication should be addressed to the publishers.

● **Declaration**

The Author and Publisher have used their best efforts in ensuring the correctness of the information contained in this book. They do not assume, and hereby disclaim, any liability to any party for any loss or damage caused by errors or omissions in this book, whether such errors or omissions result from negligence, accident, or any other cause.

All the programs given in the book are Copyright of the Author and Elektor International Media. These programs may only be used for educational purposes. Written permission from the Author or Elektor must be obtained before any of these programs can be used for commercial purposes.

● British Library Cataloguing in Publication Data

A catalogue record for this book is available from the British Library

● **ISBN 978-3-89576-481-3** Print

ISBN 978-3-89576-482-0 eBook

● © Copyright 2021: Elektor International Media B.V.

Editor: Jan Buiting

Prepress Production: D-Vision, Julian van den Berg

Elektor is part of EIM, the world's leading source of essential technical information and electronics products for pro engineers, electronics designers, and the companies seeking to engage them. Each day, our international team develops and delivers high-quality content - via a variety of media channels (including magazines, video, digital media, and social media) in several languages - relating to electronics design and DIY electronics. www.elektormagazine.com

Preface	11
Chapter 1 • Raspberry Pi Pico Hardware	12
1.1 Overview	12
1.2 Pico hardware module	12
1.3 Comparison with the Arduino UNO	14
1.4 Operating conditions and powering the Pico	15
1.5 Pinout of the RP2040 microcontroller and Pico module	16
1.6 Other RP2040 microcontroller-based boards	18
1.6.1 Adafruit Feather RP2040	18
1.6.2 Adafruit ItsyBitsy RP2040	19
1.6.3 Pimoroni PicoSystem	19
1.6.4 Arduino Nano RP2040 Connect	20
1.6.5 SparkFun Thing Plus RP2040	21
1.6.6 Pimoroni Pico Explorer Base	21
1.6.7 SparkFun MicroMod RP2040 Processor	22
1.6.8 SparkFun Pro Micro RP2040	22
1.6.9 Pico RGB Keypad Base	23
1.6.10 Pico Omnibus	23
1.6.11 Pimoroni Pico VGA Demo Base	24
1.6.12 Tiny 2040	25
Chapter 2 • Raspberry Pi Pico Programming	27
2.1 Overview	27
2.2 Installing MicroPython on Pico	27
2.2.1 Using a Raspberry Pi 4 to help install MicroPython on the Pico	27
2.2.2 Using a PC (Windows 10) to help install MicroPython on Pico	34
Chapter 3 • Simple Programs – Software Only	38
3.1 Overview	38
3.2 Examples	38
3.2.1 Average of two numbers read from the keyboard	38
3.2.2 Average of 10 numbers read from the keyboard	38
3.2.3 Surface area of a cylinder	39
3.2.4 °C to °F conversion	40

3.2.5 Surface area and volume of a cylinder – user function.	41
3.2.6 Table of squares of numbers	41
3.2.7 Table of trigonometric sine.	42
3.2.8 Table of trigonometric sine, cosine and tangent	43
3.2.9 Trigonometric function of a required angle.	43
3.2.10 Words in reverse order	44
3.2.11 Calculator	45
3.2.12 Dice	46
3.2.13 Sorting lists	47
3.2.14 File processing — writing	47
3.2.15 File processing — reading	47
3.2.16 Squares and cubes of numbers.	48
3.2.17 Multiplication timetable	48
3.2.18 Odd or even?	49
3.2.19 Binary, octal, and hexadecimal.	49
3.2.20 Add two matrices	50
3.2.21 Shapes	50
Chapter 4 • Amateur Radio Programs — Software Only	53
4.1 Overview	53
4.2 Examples	53
4.2.1 4-band resistor color code identifier.	53
4.2.2 4-band resistor color code identifier including small resistors	55
4.2.3 Resistive potential divider	57
4.2.4 Resistive attenuator design — equal source & load resistances.	59
4.2.5 Resistive attenuator design — unequal source & load resistances	63
4.2.6 Zener diode based voltage regulator.	65
4.2.7 RC circuit frequency response	69
4.2.8 Resonance in series RLC circuits	71
4.2.9 Calculating the inductance of a single-layer coil	74
4.2.10 Constructing a single-layer coil for required inductance	76
4.2.11 Bipolar junction transistor (BJT) voltage divider biasing.	77
4.2.12 Designing a common-emitter BJT transistor amplifier circuit	80

4.2.13 Designing active low-pass filters	84
4.2.14 Quarter-wave vertical antenna length	89
4.2.15 The '555' Monostable / bistable / astable chip	90
4.2. Impedance matching	96
Chapter 5 • Simple Hardware-Based Projects	99
5.1 Overview	99
5.2 Project 1: Flashing the on-board LED	99
5.3 Project 2: External flashing LED	101
5.4 Project 3: Changing the LED flashing rate using pushbutton interrupts	104
5.5 Project 4: Binary counting LEDs	109
5.6 Using parallel LCDs	112
5.7 Project 5: LCD functions — displaying text	115
5.8 Project 6: Seconds counter – Parallel LCD.	120
5.9 Using I ² C LCDs	121
5.10 Project 7: Seconds counter with I ² C LCD	121
Chapter 6 • Amateur Radio Hardware-based Projects.	125
6.1 Overview	125
6.2 Project 1: Station mains On/Off power control	125
6.3 Project 2: Station clock	129
6.4 Project 3: Station temperature and humidity	134
6.5 Project 4: Station geographical coordinates	137
6.6 Waveform generation – using software.	144
6.6.1 Project 5: Generating a squarewave signal with amplitude under +3.3 V.	145
6.6.2 Project 6: Generating fixed voltages	150
6.6.3 Project 7: Generating a sawtooth signal	152
6.6.4 Project 8: Generating a triangular-wave signal	154
6.6.5 Project 9: Arbitrary periodic waveform	156
6.6.6 Project 10: Generating a sinewave signal	158
6.6.7 Project 11: Generating an accurate sinewave signal using timer interrupts	161
6.7 Waveform generation — using hardware	163
6.7.1 Project 12: Fixed-frequency waveform generator	164

6.7.2 Project 13: Generating waveforms with frequency-entry on keypad and LCD readout 171

6.8 Project 14: Frequency counter 181

6.9 Voltmeter – Ammeter – Ohmmeter – Capacitance meter 187

6.9.1 Project 15: Voltmeter 188

6.9.2 Project 16: Ammeter. 190

6.9.3 Project 17: Ohmmeter. 190

6.9.4 Project 18: Capacitance meter 192

6.10 Project 19: RF power meter 196

6.10.1 RF attenuators 203

6.10.2 dB, dBm, and W? 204

6.11 Project 20: Using the RadioStation Click board 206

6.12 Morse Code exercisers 217

6.12.1 Project 21: Characters entered by the user 217

6.12.2 Project 22: Sending randomly generated characters 222

6.12.3 Project 23: Setting Morse speed using an LCD and a rotary encoder 225

6.13 Project 24: Relay sequencer with time delays 232

6.14 Project 25: FM radio with the Raspberry Pi Pico. 236

6.14.1 Project 26: Modified FM Radio - increasing the output signal level – connecting a loudspeaker. 244

6.14.2 Project 27: FM radio using an LCD and external buttons 246

6.14.3 Project 28: FM radio using an LCD and rotary encoder. 251

6.15 Project 29: Measure the frequency and duty cycle of a PWM waveform – screen display. 257

6.16 Project 30: Measure the frequency and duty cycle of a PWM waveform – LCD display 259

6.17 Raspberry Pi Pico Bluetooth interface 260

6.17.1 Project 31: Controlling an LED from a smartphone using Bluetooth. 260

6.18 Project 32: Station security. 265

6.19 Project 33: Generating accurate squarewave signals using the Raspberry Pi Pico State Machines 270

6.20 Project 34: Using Wi-Fi with the Raspberry Pi Pico – Controlling an LED from a smartphone 271

6.21 Project 35: Audio amplifier module with rotary encoder volume control	279
6.22 Project 36: Morse decoder	285
6.23 Raspberry Pi Pico RTL-SDR	296
6.24 Project 37: Using the FS1000A 433 MHz transmitter/receiver pair	298
Chapter 7 • Running a Program Automatically after the Raspberry Pi Pico Boots .	304
APPENDIX.	306
Parts Used in Projects	306
Index	307

Preface

In recent years, there have been major changes in the equipment typically used by radio amateurs. Although much classical HF and mobile equipment is still in use by a large number of amateurs, we see the use of computers and digital techniques gaining popularity among amateur radio operators or 'hams'. In the early days of digital communications, personal computers were used by radio amateurs to communicate with each other. Sadly, these PCs have the disadvantage of being rather expensive and bulky. Today though, anyone can buy a 5-euro Raspberry Pi Pico computer and build many interesting amateur radio projects using this device which is smaller than a credit card.

Several authors have produced books and published projects for implementing the Arduino and the Raspberry Pi in amateur radio projects. The Raspberry Pi Pico is a practical alternative to the Arduino because of its low cost, speed, processing power, large memory, many input-output ports, peripheral hardware support, and easy programming. The Raspberry Pi Pico has no operating system, and this makes it easy to use as a general-purpose microcontroller. As a result of these features, the RPi Pico is well suited for use as a "drop-in" computer for amateur radio projects.

This book has three purposes: firstly, it is aimed to teach the basic operating principles and features of the Raspberry Pi Pico to beginners. Secondly, software-only projects are presented that will be of interest to amateur radio operators. Lastly, many hardware-based projects are given using the Raspberry Pi Pico in conjunction with the Python 3 programming language. Although these projects are broad-spectrum in nature, they have been chosen to be interesting and useful to the amateur radio operators.

All the projects used in the book have been assessed and are fully working. The projects are described by giving their block diagrams, circuit diagrams, and full program listings. The program listings are described in detail and readers should find it easy to modify the projects for their own requirements.

The programs discussed in this book are available from the support and resources web page created for the book at the Elektor Store website www.elektor.com. There, the page can be found by searching for "Raspberry Pi Pico for Radio Amateurs". The .zip archive file is under "Downloads". The programs can easily be downloaded, extracted, and stored locally to save the time and effort of typing them.

I hope you enjoy reading the book and find the projects interesting and useful.

*Prof Dogan Ibrahim, G7SCU
London, 2021*

Chapter 1 • Raspberry Pi Pico Hardware

1.1 Overview

Raspberry Pi Pico is a single-board microcontroller module developed by the Raspberry Pi Foundation. The module is based on the RP2040 microcontroller chip. In this Chapter we will be looking at the hardware details of the Raspberry Pi Pico microcontroller module in some detail. From now on, we will be calling this microcontroller module "Pico" for short.

1.2 Pico hardware module

Pico is a very low-cost, \$4 microcontroller module based on the RP2040 microcontroller chip with dual Cortex-M0+ processor. Figure 1.1 shows the front view of the Pico hardware module which is a small board. At the middle of the board is the tiny 7×7 mm RP2040 microcontroller chip housed in a QFN-56 package. At the two edges of the board there are forty gold-colored metal GPIO (General Input Output) pins with holes. You should solder pins to these holes so that external connections can be made easily to the board. The holes are marked starting with number 1 at the top left corner of the board and the numbers increase downwards up to number 40 which is at the top right hand corner of the board. The board is breadboard compatible (i.e., 0.1-inch pin spacing), and after soldering the pins, the board can be plugged on a breadboard for easy connection to the GPIO pins using jumper wires. Next to these holes you will see bumpy circular cut-outs which can be plugged-in on top of other modules without having any physical pins fitted.

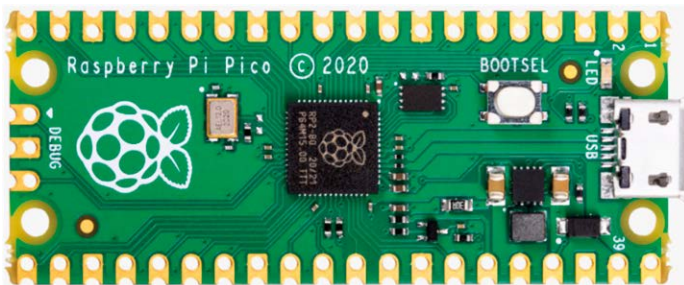

Figure 1.1: Front view of the Pico hardware module.

At one edge of the board there is the micro-USB B port for providing power to the board and for programming the board. Next to the USB port sits an on-board user LED that can be used during program development. Next to this LED there is a button named as BOOTSEL which is used during programming of the microcontroller as we will see in next Chapters. At the other edge of the board, next to the Raspberry Pi logo, there are three connectors that are used to debug your programs.

Figure 1.2 shows the back view of the Pico hardware module. Here, all the GPIO pins are identified with letters and numbers. You will notice the following types of letters and numbers:

GND	—	power supply ground (digital ground)
AGND	—	power supply ground (analog ground)
3V3	—	+3.3 V power supply (output)
GP0 – GP22	—	digital GPIO
GP26_A0 – GP28_A2	—	analog inputs
ADC_VREF	—	ADC reference voltage
TP1 – TP6	—	test points
SWDIO, GND, SWCLK	—	debug interface
RUN	—	default RUN pin. Connect LOW to reset the RP2040

3V3_EN	—	this pin by default enables the +3.3 V power supply. +3.3 V can be disabled by connecting this pin LOW
VSYS	—	system input voltage (1.8 V to 5.5 V) used by the on-board SMPS to generate +3.3 V supply for the board
VBUS	—	micro-USB input voltage (+5 V)

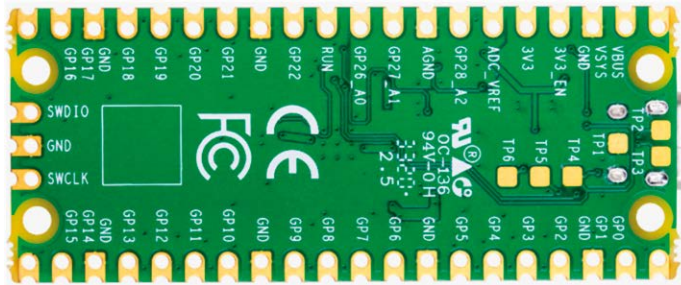

Figure 1.2: Back view of the Pico hardware module.

Some of the GPIO pins are used for internal board functions. These are:

GP29 (input)	—	used in ADC mode (ADC3) to measure VSYS/3
GP25 (output)	—	connected to on-board user LED
GP24 (input)	—	VBUS sense HIGH if VBUS is present, else LOW
GP23 (output)	—	Controls the on-board SMPS Power Save pin

The specifications of the Pico hardware module are as follows:

- 32-bit RP2040 Cortex-M0+ dual core processor operating at 133 MHz
- 2 MByte Q-SPI Flash memory
- 264 Kbyte SRAM memory
- 26 GPIO (+3.3 V compatible)
- 3 × 12-bit ADC pins
- Serial Wire Debug (SWD) port
- Micro-USB port (USB 1.1) for power (+5 V) and data (programming)
- 2 × UART, 2 × I²C, 2 × SPI bus interface
- 16 × PWM channels

- 1 x Timer (with 4 alarms), 1 x Real Time Counter
- On-board temperature sensor
- On-board LED (on port GP25)
- MicroPython, C, C++ programming
- Drag & drop programming using mass storage over USB

The Pico's GPIO hardware is +3.3 V compatible, and it is therefore important to be careful not to exceed this voltage when interfacing external devices to the GPIO pins. +5 V to +3.3 V logic converter circuits or resistive potential divider circuits must be used if it is required to interface devices with +5 V outputs to the Pico GPIO pins.

Figure 1.3 shows a resistive potential divider circuit that can be used to lower +5 V to +3.3 V. A logic level converter module is shown in Figure 1.4. This module can be used to interface the Pico pins to +5 V devices. Connect GND pins to ground, and HV and LV pins to +5 V and +3.3 V, respectively. Use TXI-TXO pins to connect the +3.3 V Pico outputs to +5 V input devices. Similarly, use RXI-RXO pins to connect +5 V output devices to +3.3 V Pico input pins.

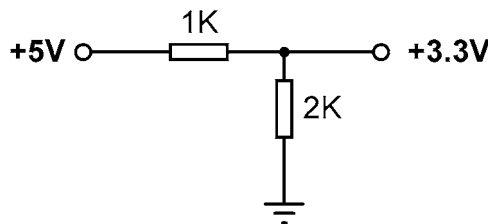

Figure 1.3: Resistive potential divider circuit.

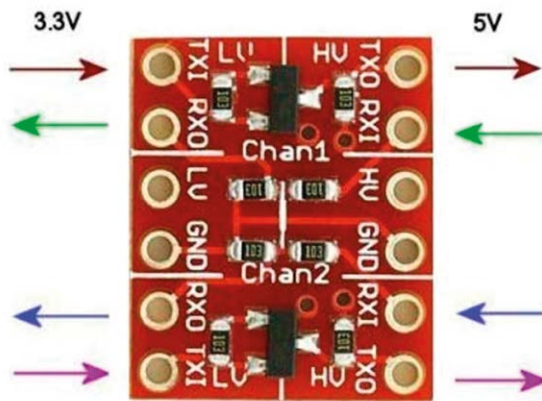

Figure 1.4: Logic converter module.

1.3 Comparison with the Arduino UNO

The Arduino UNO is one of the most popular microcontroller development boards used by students, practicing engineers, and hobbyists. Both the Arduino UNO and Raspberry Pi Pico module are microcontrollers with no operating systems. Table 1.1 shows a comparison of

the Raspberry Pi Pico with the Arduino UNO. It is clear from this table that the Pico is much faster than the Arduino UNO, has larger flash and data memories, provides more digital input-output pins, and has an on-board temperature sensor. The Arduino UNO operates at +5 V and its GPIO pins are +5 V compatible. Some advantages of the Arduino UNO include its built-in EEPROM memory and its ADC with six channels instead of three as in the Pico.

Feature	Raspberry Pi Pico	Arduino UNO
Microcontroller	RP2040	Atmega328P
Core and bits	Dual core, 32-bits, Cortex-M0+	Single-core 8-bits
RAM	264 Kbyte	2 KByte
Flash	2 MByte	32 KByte
CPU speed	48 MHZ to 133 MHZ	16 MHZ
EEPROM	None	1 KByte
Power input	+5 V through USB port	+5 V through USB port
Alternative power	2–5 V via VSYS pin	7–12 V
MCU operating voltage	+3.3 V	+5 V
GPIO count	26	20
ADC count	3	6
Hardware UART	2	1
Hardware I²C	2	1
Hardware SPI	2	1
Hardware PWM	16	6
Programming languages	MicroPython, C, C++	C (Arduino IDE)
On-board LED	1	1
Cost	\$4	\$20

Table 1.1: Comparison of Raspberry Pi Pico and Arduino UNO.

1.4 Operating conditions and powering the Pico

The recommended operating conditions of the Pico are:

- Operating temperature: –20 °C to +85 °C
- VBUS voltage: +5 V ±10%
- VSYS voltage: +1.8 V to +5.5 V

An on-board SMPS is used to generate the +3.3 V to power the RP2040 from a range of input voltages from 1.8 V to +5.5 V. For example, three alkaline AA batteries can be used to provide +4.5 V to power Pico.

Pico can be powered in several ways. The simplest method is to plug the micro-USB port to a +5 V power source, such as the USB port of a computer or a +5 V power adapter. This will provide power to the VSYS input (see Figure 1.5) through a Schottky diode. The voltage at the VSYS input is therefore VBUS voltage minus the voltage drop of the Schottky diode (about +0.7 V). VBUS and VSYS pins can be shorted if the board is powered from an external +5 V USB port. This will increase the voltage input slightly and hence reduce ripples on VSYS. VSYS voltage is fed to the SMPS through the RT6150 which generates a fixed +3.3 V supply for the MCU and other parts of the board. VSYS is divided by three and is available at analog input port GPIO29 (ADC3), which can easily be monitored. GPIO24 checks the existence of VBUS voltage and is at logic HIGH if VBUS is present.

Another method to power the Pico is by applying an external voltage (+1.8 V to +5.5 V) to the VSYS input directly (e.g., using batteries or external power supply). We can also use the USB input and VSYS inputs together to supply power to Pico, for example, to allow operation from both batteries and the USB port. If this method is used, then a Schottky diode should be used at the VSYS input to prevent the supplies from interfering with each other. The higher of the voltages will power VSYS.

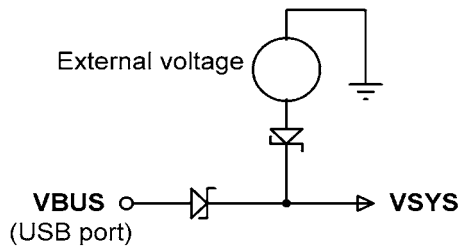

Figure 1.5: Powering the Pico.

1.5 Pinout of the RP2040 microcontroller and Pico module

Figure 1.6 shows the RP2040 microcontroller pinout, which is housed in a 56-pin package. The Pico module pinout is shown in Figure 1.7 in detail. As you can see from the figure, most pins have multiple functions. For example, GPIO0 (pin 1) is also the UART0 TX, I2C0 SDA, and the SPI0 RX pins.

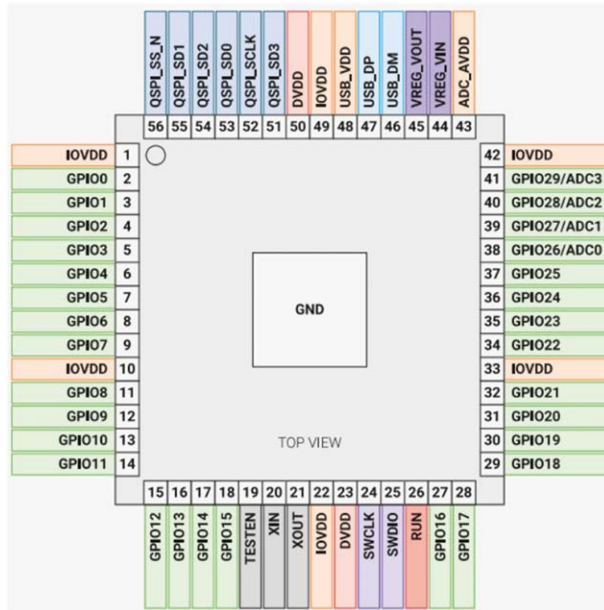

Figure 1.6: RP2040 microcontroller pinout.

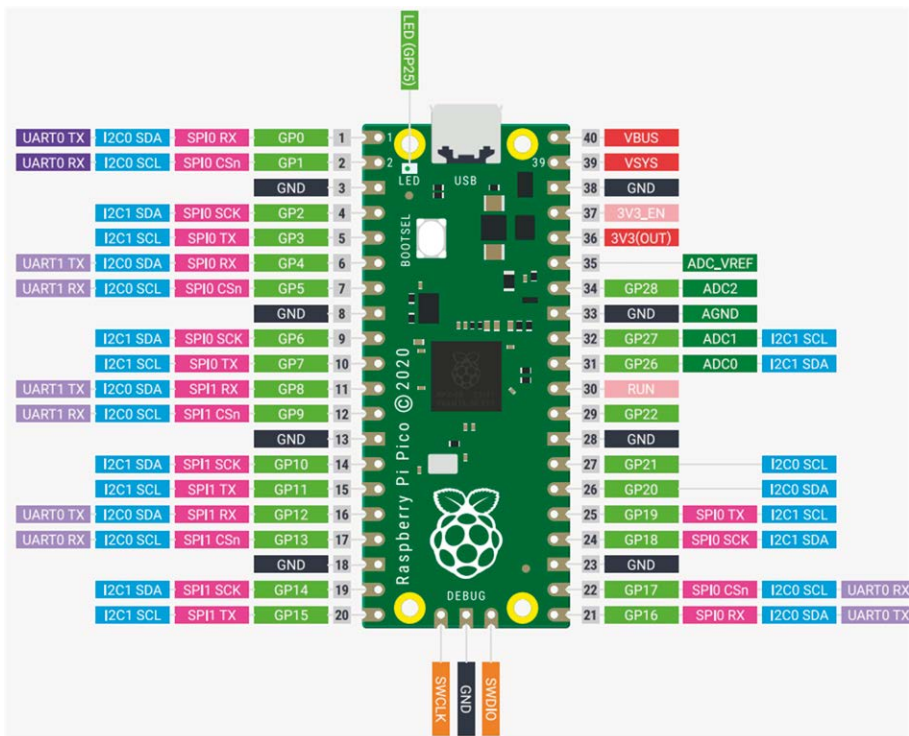

Figure 1.7: Pico pinout.

Figure 1.8 shows a simplified block diagram of the Pico hardware module. Notice that the GPIO pins are directly connected from the microcontroller chip to the GPIO connector. GPIO numbers 26, 27, 28 can be used either as digital GPIO or as ADC inputs. ADC inputs GPIO26-29 have reverse polarity diodes to 3 Vs and therefore the input voltage must not exceed $3V3 + 300\text{ mV}$. Another point to note is that if the RP2040 is not powered, applying voltages to GPIO26-29 pins may leak through the diode to the power supply. There is no problem with the other GPIO pins, and voltage can be applied safely when the RP2040 is not powered.

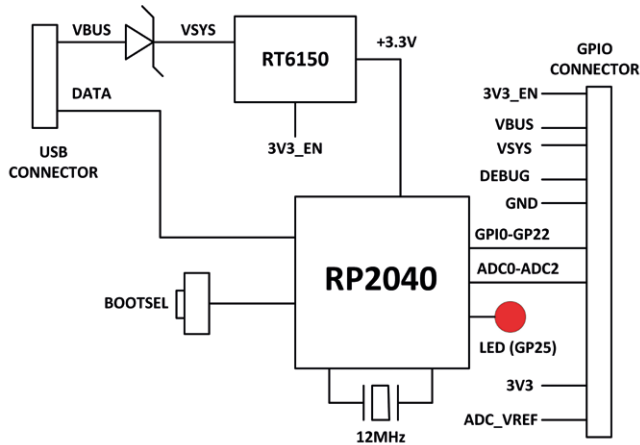

Figure 1.8: Simplified block diagram.

1.6 Other RP2040 microcontroller-based boards

While authoring this book, some third-party manufacturers have been developing microcontrollers based on the RP2040 chip. Some examples are given in this section.

1.6.1 Adafruit Feather RP2040

This microcontroller board (Figure 1.9) has the following basic specifications:

- RP2040 32-bit Cortex-M0+ running at 125MHz
- 4 MB Flash memory
- 264 KB RAM
- 4 × 12-bit ADC
- 2 × I²C, 2 × SPI, 2 × UART
- 16 × PWM
- 200 mA LiPo charger
- Reset and Bootloader buttons
- 24 MHz crystal
- +3.3 V regulator with 500 mA current output
- USB type C connector
- On-board red LED
- RGB NeoPixel
- On-board STEMMA QT connector with optional SWD debug port

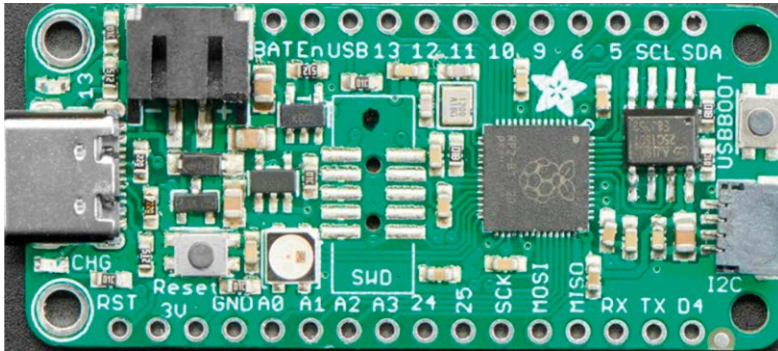

Figure 1.9: Adafruit Feather RP2040.

1.6.2 Adafruit ItsyBitsy RP2040

The ItsyBitsy RP2040 (Figure 1.10) is another RP2040-based microcontroller board from Adafruit. Its basic features are similar to Feather RP2040. It has a USB-micro B connector and provides +5 V output.

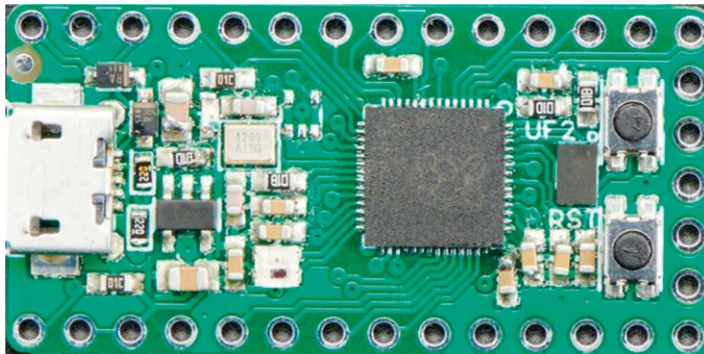

Figure 1.10: Adafruit ItsyBitsy RP2040.

1.6.3 Pimoroni PicoSystem

This is a mini gaming board (Figure 1.11) developed around the RP2040 microcontroller. Its basic features are:

- 133 MHz clock
- 264 KB SRAM
- LCD screen
- Joypad
- Buttons
- LiPo battery
- USB-C power connector



Figure 1.11: Pimoroni PicoSystem.

1.6.4 Arduino Nano RP2040 Connect

This board (Figure 1.12) offers 16 MB flash, a 9-axis IMU, a microphone, plus a very efficient power section equipped with Wi-Fi/Bluetooth. It includes a u-blox NINA-W102 radio module to make the unit IoT compatible. A built-in microphone (MP34DT05) is available for sound activation, audio control, and even AI voice recognition. The 6-axis smart IMU (LSM6DSOXTR) with AI capabilities tells the board which way it is moving and adds fall sensing and double-tap activation. It includes full Wi-Fi 802.11b/g/n connectivity, along with Bluetooth® and BLE v4.2. Supports the Arduino programming language, the IDE 2.0 and all the associated libraries.

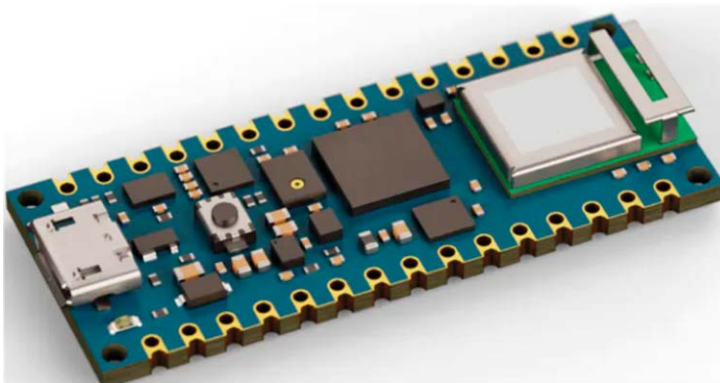

Figure 1.12: Arduino Nano RP2040 Connect.

1.6.5 SparkFun Thing Plus RP2040

This development platform (Figure 1.13) provides an SD card slot, 16MB flash memory, a JST single cell battery connector, a WS2812 RGB LED, JTAG pins, and Qwiic connector. Its basic features are:

- 133 MHz speed
- 264 KB SRAM
- 4 × 12-bit ADC
- 2 × UART, 2 × I²C, 2 × SPI
- 16 × PWM
- 1 × timer with 4 alarms

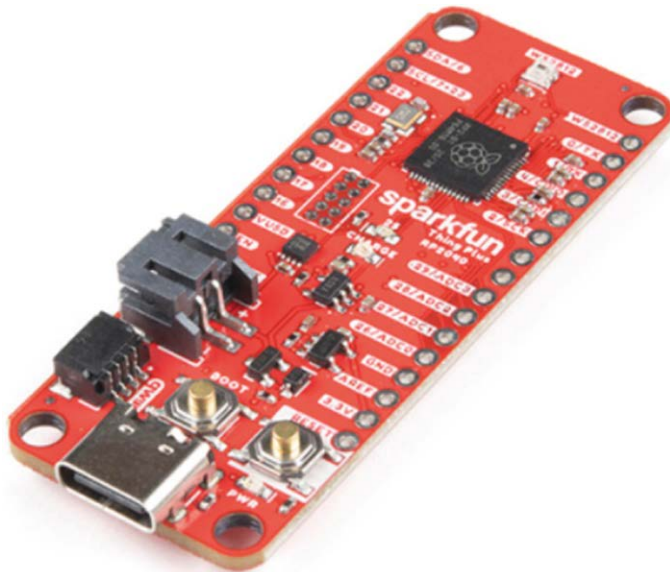

Figure 1.13: SparkFun Thing Plus RP2040.

1.6.6 Pimoroni Pico Explorer Base

This development board (Figure 1.14) includes a small breadboard and a 240 × 240 IPS LCD display with four tactile buttons. A socket is provided on the board to plug-in a Raspberry Pi Pico board. The basic features of this development board are:

- Piezo speaker
- 1.54 inch IPS LCD
- 4 × buttons
- 2 × half-bridge motor drives
- Two breakout I²C sockets
- Easy access to GPIO and ADC pins
- Mini breadboard
- No soldering required
- Raspberry Pi Pico not supplied

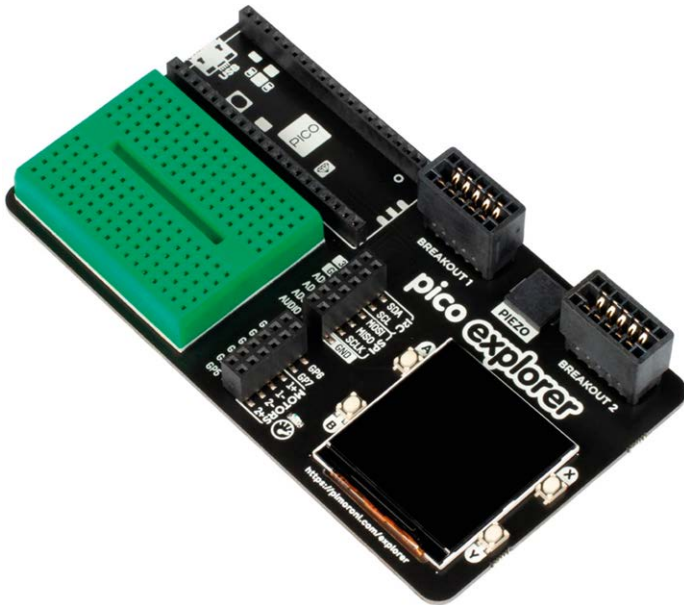

Figure 1.14: Pimoroni Pico Explorer Base.

1.6.7 SparkFun MicroMod RP2040 Processor

This board (Figure 1.15) includes a MicroMod M.2 connector for access to the GPIO pins.

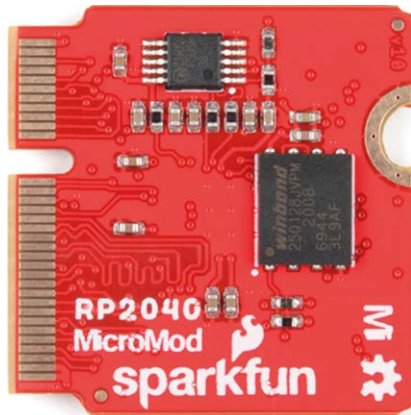

Figure 1.15: SparkFun MicroMod RP 2040 Processor.

1.6.8 SparkFun Pro Micro RP2040

This board (Figure 1.16) includes an ES2812B addressable LED, a boot button, a reset button, a Qwiic connector, a USB-C power interface, a PTC fuse, and castellated GPIO pads.

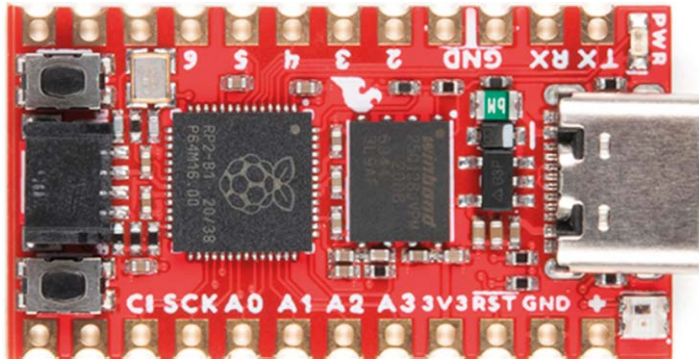

Figure 1.16: SparkFun Pro Micro RP2040.

1.6.9 Pico RGB Keypad Base

This board is equipped with 4 × 4 rainbow-illuminated keypad (Figure 1.17) with APA102 LEDs. The basic features are:

- 4 × 4 keypad
- 16 × APA102 RGB LEDs
- Keypad connected via I²C I/O expander
- labelled GPIO pins

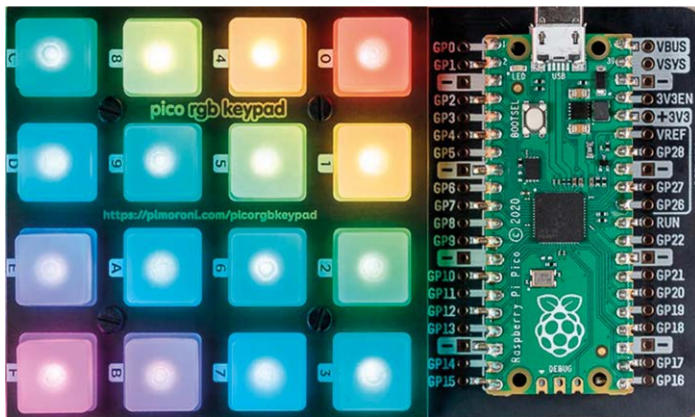

Figure 1.17: Pico RGB Keypad Base.

1.6.10 Pico Omnibus

This is an expansion board for the Pico (Figure 1.18). Basic features of this board are:

- labelled GPIO pins
- Two landing areas with labelled (mirrored) male headers for attaching add-ons.
- 4 × rubber feet
- Compatible with Raspberry Pi Pico.
- Fully assembled.
- Dimensions: approx. 94 × 52 mm × 12 mm

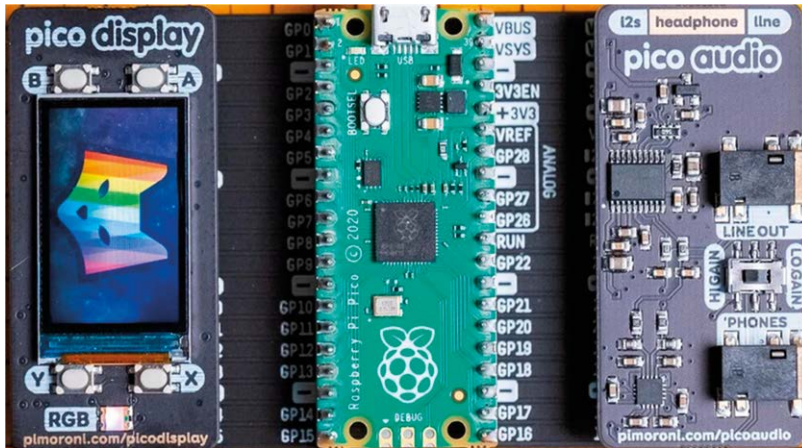

Figure 1.18: Pico Omnibus.

1.6.11 Pimoroni Pico VGA Demo Base

This board (Figure 1.19) has VGA output and an SD card slot. The basic features are:

- Powered by Raspberry Pi Pico
- 15-pin VGA connector
- I²S DAC for line out audio
- PWM audio output
- SD card slot
- Reset button
- Headers to install your Raspberry Pi Pico
- Three user switches
- No soldering required



Figure 1.20: Tiny 2040

Chapter 2 • Raspberry Pi Pico Programming

2.1 Overview

At the time of authoring this book, the Raspberry Pi Pico could be programmed using the following programming languages:

- C/C++
- MicroPython
- Assembly language

Although the Pico by default is set up for use with the powerful and popular C/C++ language, many beginners find it easier to use MicroPython, which is a version of the Python programming language developed specifically for microcontrollers.

In this Chapter we will learn how to install and use the MicroPython programming language. We will be using the Thonny text editor which has been developed specifically for Python programs.

Many working and fully tested projects will be given in the next Chapters using MicroPython with our Pico.

2.2 Installing MicroPython on Pico

MicroPython must be installed on the Pico before it can be used. Once it is installed it stays on your Pico unless it is overwritten with something else. Installing MicroPython requires an Internet connection, although only once. Since the Pico has no Wi-Fi connectivity, we will need to use a computer with Internet access. This can be done either by using a Raspberry Pi (e.g., a Raspberry Pi 4), or by using a PC. In this section we will see how to do the installation using both methods.

2.2.1 Using a Raspberry Pi 4 to help install MicroPython on the Pico

The steps are as follows:

- Boot your Raspberry Pi 4 and login to Desktop.
- Make sure your Raspberry Pi is connected to the Internet.
- Hold down the **BOOTSEL** button on your Pico.
- Connect your Pico to one of the USB ports of the Raspberry Pi 4 using a micro-USB cable while holding down the button.
- Wait a few seconds and let go the **BOOTSEL** button.
- You should see the Pico appear as a removable drive. Click **OK** in the **Removable medium is inserted** window (Figure 2.1).

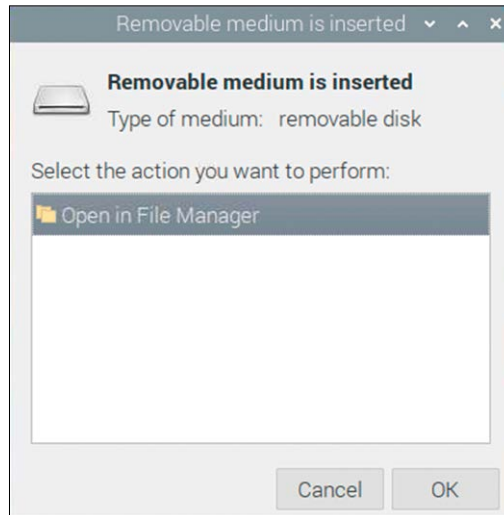

Figure 2.1: Click OK.

- In the **File Manager** window, you will see two files with the names **INDEX.HTM** and **INFO_UF2.TXT** (see Figure 2.2).

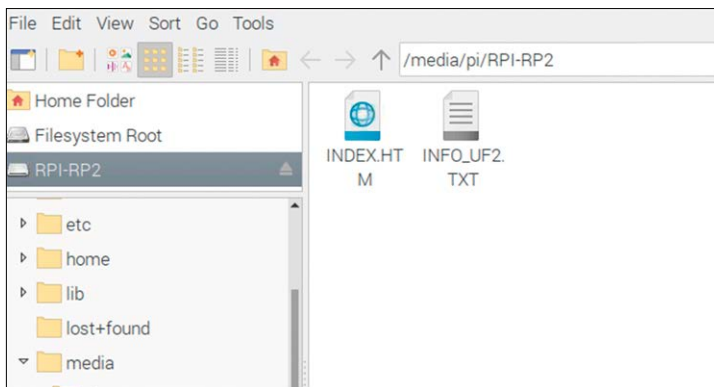

Figure 2.2: You will see two files.

- Double click on file **INDEX.HTM** and scroll down.
- You should see the message **Raspberry Pi Documentation** displayed in a web page (Figure 2.3).

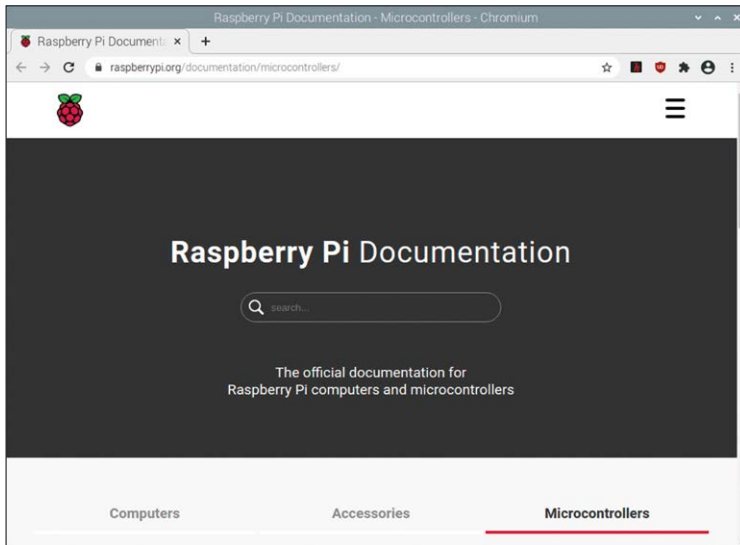

Figure 2.3: Displayed message.

- Scroll down and click on the **MicroPython** tab and then click **Download UF2 file** to download the **MicroPython** firmware (Figure 2.4). You should see the downloaded file message at the bottom of the screen (Figure 2.5).

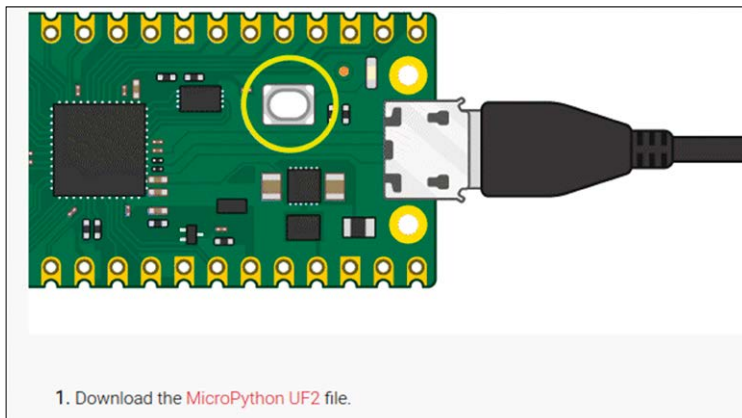

Figure 2.4: Download UF2 file.

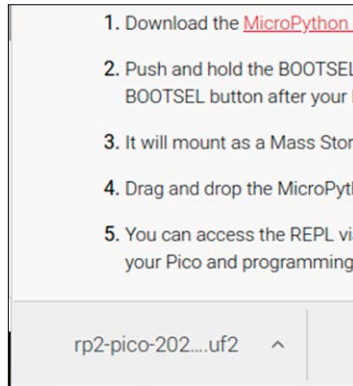

Figure 2.5: Downloaded message.

- Close your browser window by clicking on the cross icon located at the top right corner.
- Open the **File Manager** by clicking on menu, followed by **Accessories**.
- Open the **Downloads** folder (under **/home/pi**) and locate the file with the extension: **.uf2**. This file will have the name similar to: **rp2-pico-20210902-v1.17.uf2** (Figure 2.6).

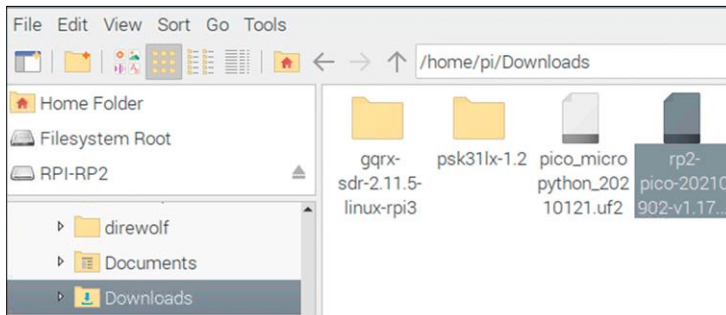

Figure 2.6: Locate file with extension: `.uf2`.

- Drag and drop this file onto the Raspberry Pi Pico's removable drive called: **RPI-RP2** (at the top left side of the screen – see Figure 2.6).
- After a while, the **MicroPython** firmware will be installed onto the internal storage of the Pico and the drive will disappear. Close the window.
- Your Pico is now running **MicroPython**.
- Powering down the Pico will not remove MicroPython from its memory.

Using the Thonny text editor from Raspberry Pi

Thonny is a free Python Integrated Development Environment (IDE) developed specifically for Python. It has built-in text editor and debugger and a number of other utilities that can be useful during program development.

In this section we will learn how to use the Thonny by invoking it from the Raspberry Pi. You should leave your Pico connected to the Raspberry Pi. We will create a one-line program to display the message **Hello from Raspberry Pi Pico**:

The steps are:

- Click menu, followed by **Programming** on your Raspberry Pi Desktop and then click **Thonny Python IDE** (see Figure 2.7). The author had version 3.7.3 of Thonny installed on his Raspberry Pi 4.

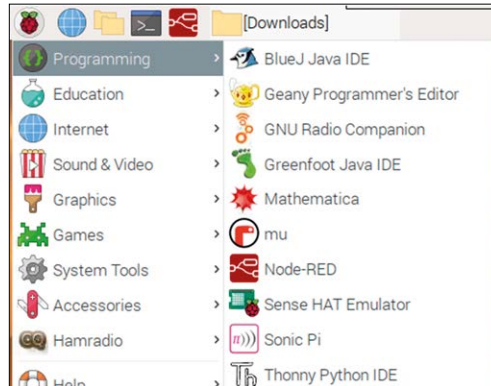

Figure 2.7: Start Thonny on your Raspberry Pi.

- Click on the label **Python** at the bottom right hand corner of Thonny (Figure 2.8).



Figure 2.8: Click "Python" in the bottom right-hand corner.

- Click to select **MicroPython (Raspberry Pi Pico)** as shown in Figure 2.9.

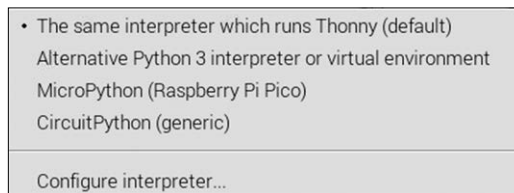

Figure 2.9: Select Raspberry Pi Pico.